



Ceramic Resonator

SMD-version
KX-ZTT C series

Built-in capacitor types

part no.	12.99507
model	KX-ZTT CS MX
frequency	20.0 MHz
internal capacitance C ₁ , C ₂	10 pF
frequency tolerance at +25°C	±0.5%
frequency stability at -20° ~ +80°C	±0.3%
aging for 10 years	±0.3%
resonant resistance max.	40 Ohm
test circuit IC	TC 74 HCU04
contents of reel	1000 pcs.

Please note for Ceramic Resonators our „Precautions for Handling“.

Dimensions (mm):

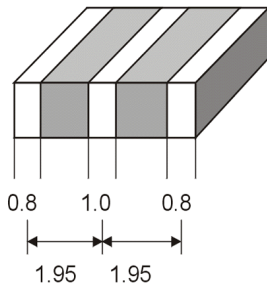
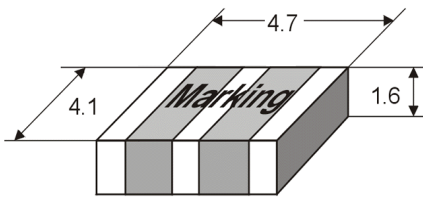

Reflow soldering condition:

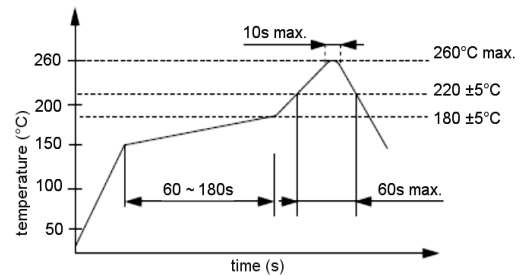

Test circuit7

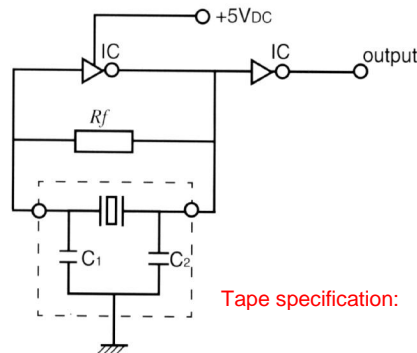

Suggested soldering pad:

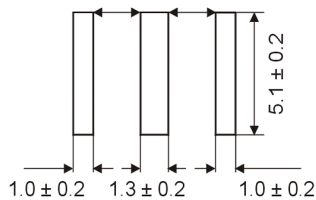

Tape specification:

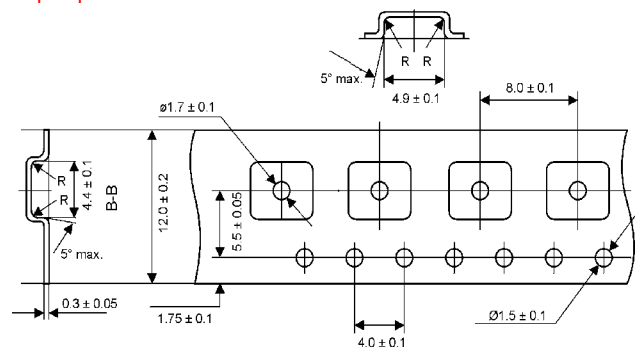

reel diameter 178 mm