



Ceramic Resonator

SMD-version
KX-ZTT C series

Built-in capacitor types

part no.	12.99503
model	KX-ZTT CS MT
frequency	10.0 MHz
internal capacitance C ₁ , C ₂	22 pF
frequency tolerance at +25°C	±0.5%
frequency stability at -20° ~ +80°C	±0.4%
aging for 10 years	±0.4%
resonant resistance (max.)	80 Ohm
test circuit IC	CD 4069 UBXP2
contents of reel	1000 pcs.

Please note for Ceramic Resonators our „Precautions for Handling“.

Dimensions (mm):

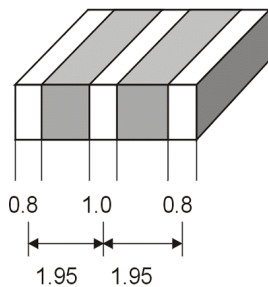
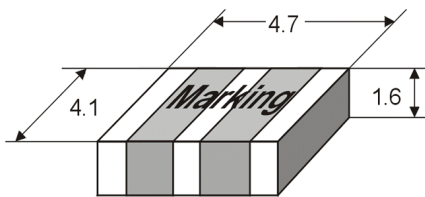

Reflow soldering condition:

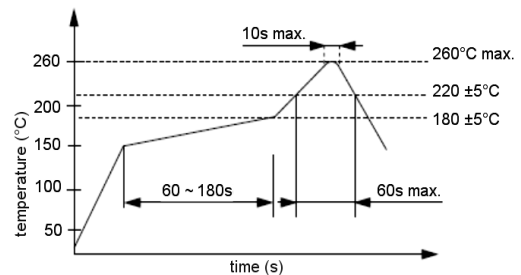

Test circuit7

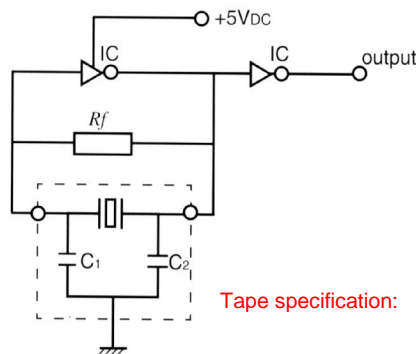

Tape specification:

Suggested soldering pad:

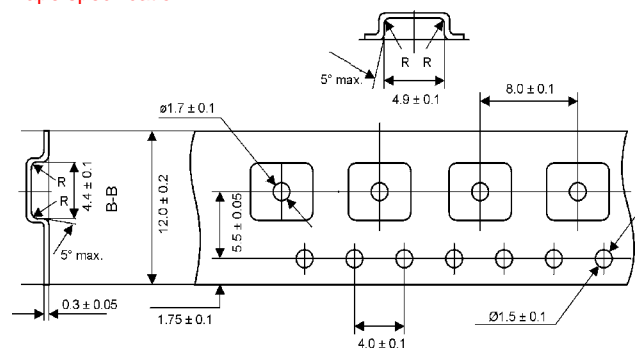
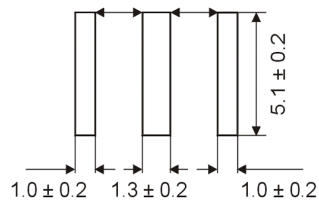

reel diameter 178 mm