



Quartz Crystal

SMD-version

model	KX - KT
frequency	4,91520 MHz
mode	fundamental
operating temperature	-40° ~ +85°C
frequency tolerance at +25°C	± 50 ppm
temperature tolerance at -40° ~ +85°C	± 100 ppm
load capacitance C_L	16 pF
series resonance R1 max.	120 Ohm
aging at 25°C (first year) max.	± 2 ppm
shunt capacitance C_0 max.	7,0 pF
drive level	0,1 mW
contents of reel	1000 pcs.
part no.	12.88168

Dimensions (mm):

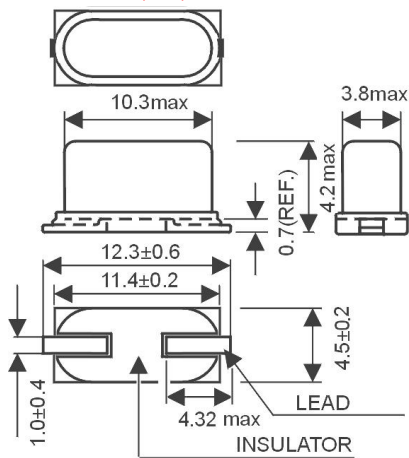

Suggested soldering pad:

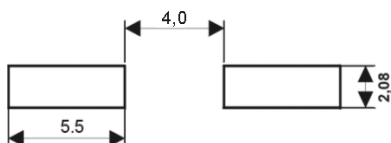

Reflow soldering condition:

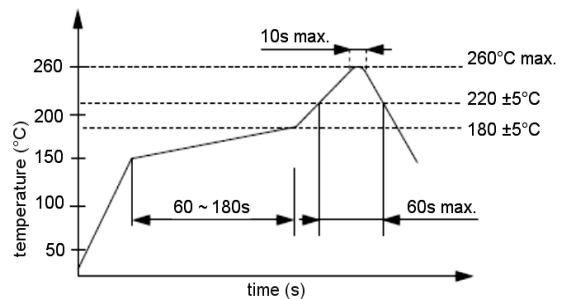

Tape specification:

