



Quartz Crystal

SMD-version

model	KX - 13
frequency	6,0 MHz
mode	fundamental
operating temperature	-20° ~ + 70°C
frequency tolerance at +25°C	± 30 ppm
temperature tolerance at -20° ~ + 70°C	± 50 ppm
load capacitance C_L	16 pF
series resonance R_1 max.	120 Ohm
aging at 25°C (first year) max.	± 2 ppm
shunt capacitance C_0 max.	7,0 pF
drive level in mW	0,05
RoHS	according to RoHS 2011/65/EU
contents of reel	1000 pcs.
part no.	12.87971

Dimensions (mm):

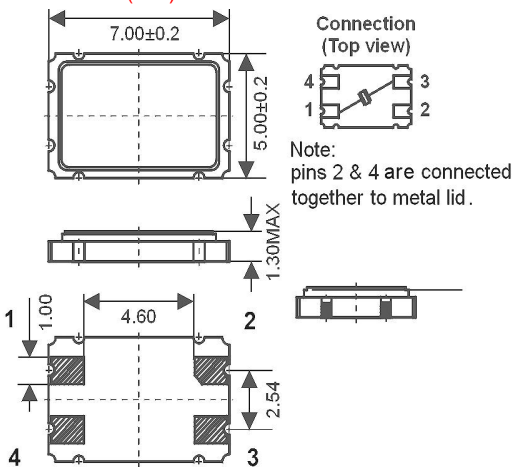

Reflow soldering condition:

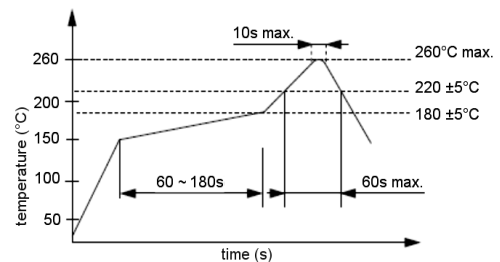

Tape specification:

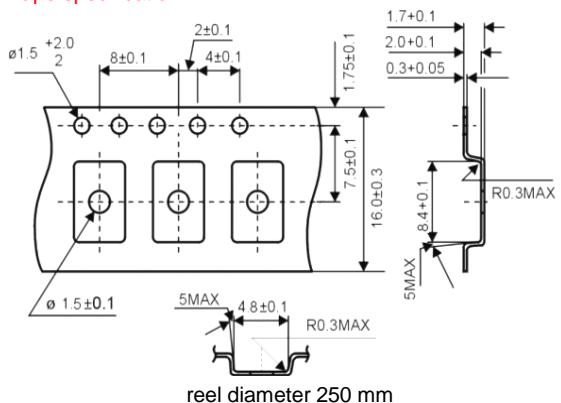

Suggested soldering pad:

