



Quartz Crystal

SMD-version

part no.	12.87703
model	KX – 12B
frequency	12.0 MHz
mode	fundamental
operating temperature	-20° ~ +70°C
frequency tolerance at +25°C	±30 ppm
temperature tolerance -20° ~ +70°C	±50 ppm
load capacitance C_L	16 pF
series resonance R_1 max.	60 Ohm
aging at 25°C (first year) max.	±2 ppm
shunt capacitance C_0 max.	7.0 pF
drive level max.	0.05 mW
contents of reel	1000 pcs.

Dimensions (mm):

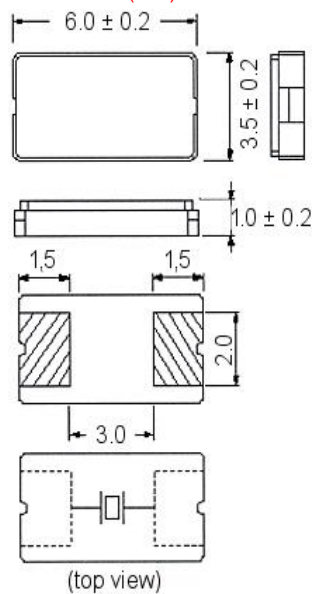

Suggested soldering pad:

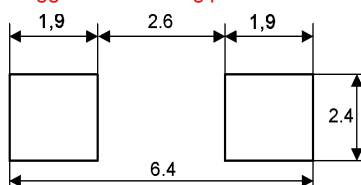

Reflow soldering condition:

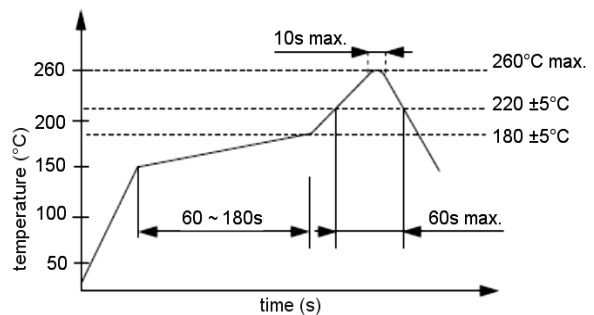

Tape specification:

