

## Quartz Crystal

SMD-version

model	KX – 5
frequency	19,20 MHz
mode	fundamental
operating temperature	-20° ~ +70°C
frequency tolerance at +25°C	± 30 ppm
temperature tolerance -20° ~ +70°C	± 50 ppm
load capacitance $C_L$	8 pF
series resonance R1 max.	200 Ohm
aging at +25°C (first year) max.	± 2 ppm
shunt capacitance $C_0$ max.	3,5 pF
drive level	50 $\mu$ W typ., 100 $\mu$ W max.
contents of reel	1000 pcs.
part no.	12.85507

### Dimensions (mm):

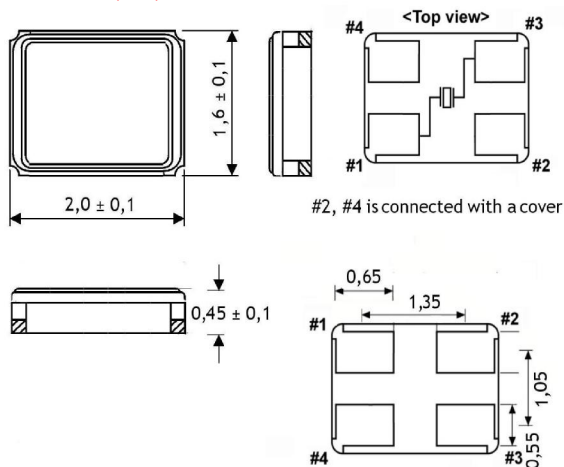

### Reflow soldering condition:

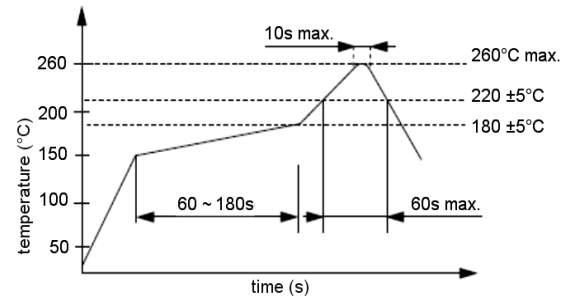

### Suggested soldering pad:

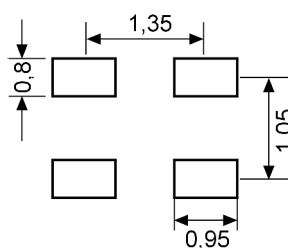

### Tape specifications:

